

Instruction of TVJT320ND2 Wall fixed installation

1.Product Features













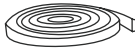









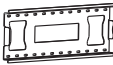







TVJT320ND2 Product weight:22kg; TV size support:32-80"; Maximum load:50kg;
For VESA standard: 400x400mm 600x400 800x600mm

2.Hardware List

Important: We are not responsible for any personal injury or product damage due to mishandling, incorrect mounting, incorrect assembly or incorrect use of this product.

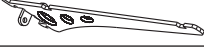
Caution: This LCD/Plasma wall mount is intended for use with television that does not exceed the maximum weight capacity designated. Using this mount with products heavier than the maximum weight indicated may result in instability causing possible injury.

Screw spare parts list

<p>1.Product Features</p> <p>TVJT320ND2 Product weight:22kg; TV size support:32-80"; Maximum load:50kg; For VESA standard: 400x400mm 600x400 800x600mm</p> <p>2.Hardware List</p> <p>Important: We are not responsible for any personal injury or product damage due to mishandling, incorrect mounting, incorrect assembly or incorrect use of this product.</p> <p>Caution: This LCD/Plasma wall mount is intended for use with television that does not exceed the maximum weight capacity designated. Using this mount with products heavier than the maximum weight indicated may result in instability causing possible injury.</p>				14		The locking block	x2
				15		The locking block	x2
				16		Projector tray	x1
				17		Safety belt	x1
				A		M12x40mm Cross round screw	x4
				B		M6x65mm Cross round screw	x12
				C		Φ6 washer	x22
				D		M6 Nut	x4
				E		M8x40mm Cross round screw	x4
				F		M4x10mm Cross round screw	x8
				G		M6x20mm Cross round screw	x4
				H		Φ6 plastic spacer	x4
				I		Φ8 plastic spacer	x4
				Screw spare parts list			
No.	Description	Specifications Model	Qty.	K		plastic cage	x8
1		Panel 1	x1	L		Φ12 washer	x2
2		Arm	x2	M		Φ8 washer	x2
3		Bar	x1	N		Adjustable angle screw	x2
4		pedestal 1	x2	O		M6x10mm Cross round screw	x4
5		pedestal 2	x2	P		M6x15mm flat head screw	x2
6		pedestal 3	x2	Q		M6x16mm Cross round screw	x2
7		DVD frame	x2	Instruction of installation operation			
8		pedestal 4	x1				
9		DVD shelf	x4				
10		DVD board	x2				
11		Wheel 1	x2				
12		Wheel 2	x2				
13		tube	x2				

1

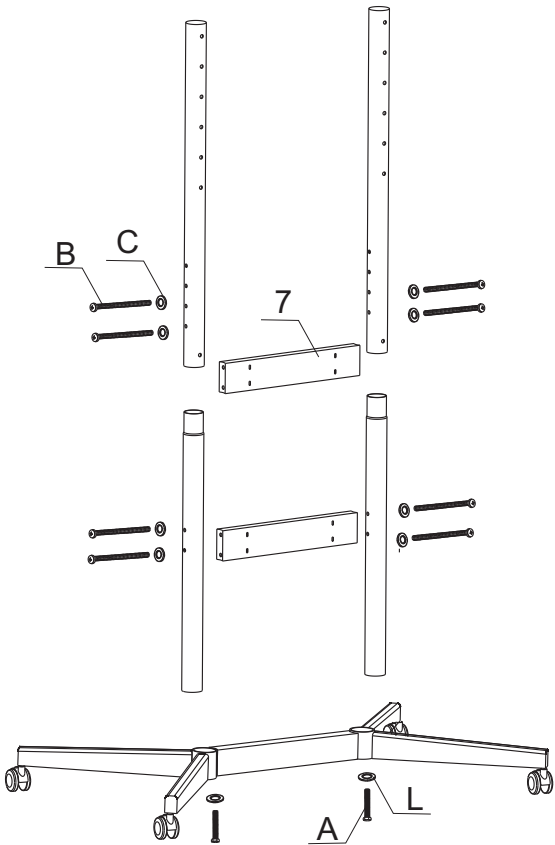
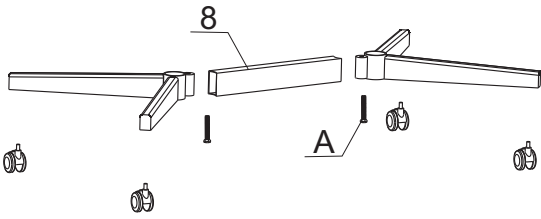

2

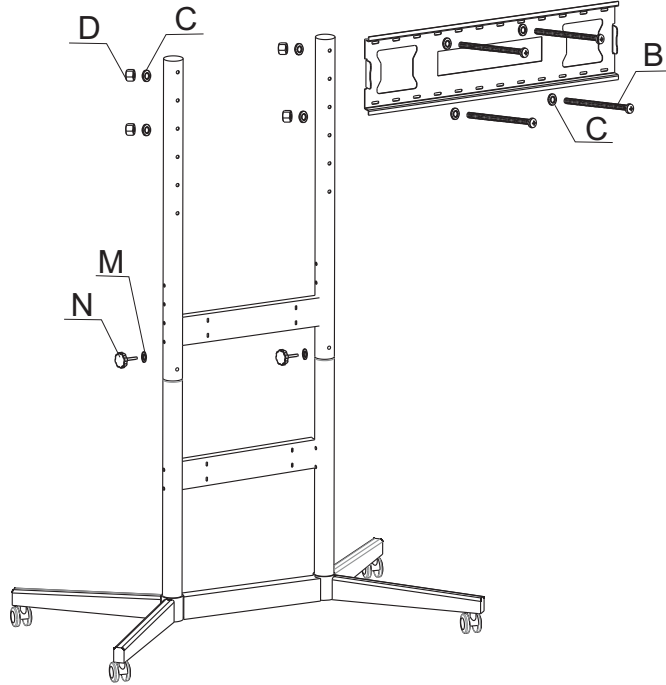

4

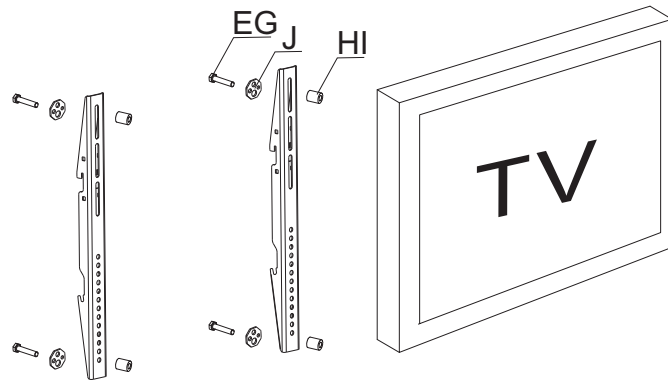

3

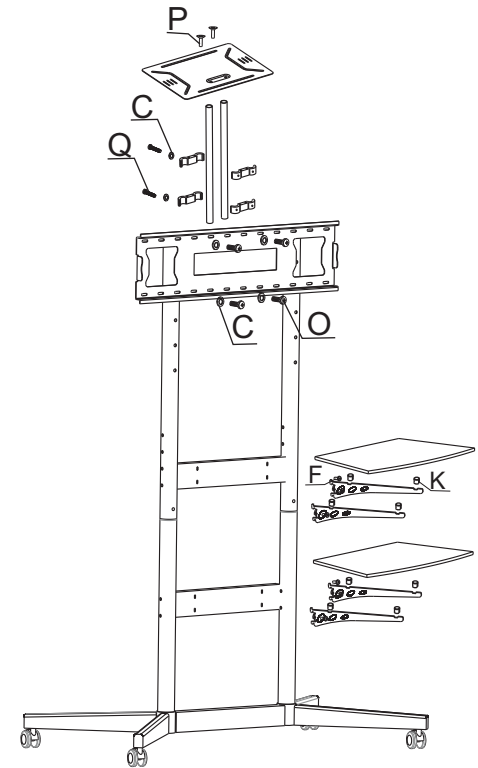

5

